

m o o o i<sup>®</sup>



## Boutique Eyes Of Strangers

---

In whatever mirror we look... we will meet the rare eyes of strangers

---

<b>Designer</b>	Marcel Wanders
<b>Year of design</b>	2010
<b>Material</b>	pattern fabric material; 24% polyester 47% cotton, 29% linen plain fabric material; 27% polyester 42% cotton, 31% linen
<b>Additional</b>	COF (clients own fabric) is also available with this sofa.

---

---

## fabric



### cover - cushions - pillows

#### composition

24% Polyester  
47% Cotton  
29% Linen

#### abrasion

20.000 Martindale

#### firetest

BS 5852, ig. s. 2-5  
EN 1021-1/2  
US Cal. Tech. Bull. 117

---

## a sofa to fit your personal style, to outlast everyday interiors and to keep up to date forever!

Conceived, developed and designed by Marcel Wanders for Moooi, the Boutique sofa is a timeless piece of furniture. The Boutique sofa contours, dimensions and sheer comfort makes it highly sitter-friendly. With a unique artistic temperament and specially designed fabrics & patterns, it makes it the perfect sofa to brighten up your interior.

The archetype classical form makes this sofa collection ideal to dress with any of the 20 different creative, detailed and fashionable covers. To top it all you can also choose between 5 types of feet! Together, it makes a huge range of possibilities.

---

## boutique feet

Personalize your Boutique sofa with one of these feet.



**pawn**  
Beech with  
plastic cap



**heel**  
Aluminium with  
plastic cap



**toes black**  
Casted Aluminium  
with plastic cap



**toes chromed**  
Casted  
Aluminium with  
plastic cap



**skis**  
Chromed steel  
with felt sliders

## boutique covers

You will receive your Boutique sofa dressed with the cover of your choice but changing your Boutique sofa cover is always easy, as all Boutique sofa covers are tailored to fit and simply attached to the sofa with user friendly Velcro fastenings.



















The sofa is upholstered in an extra beautiful underwear fabric to make the installation of a new cover effortless and exciting.

The moment you order your Boutique sofa you can expect it within 2 to 4 weeks.

Moooi will continue to design new covers so that you can keep on bringing the latest style and feel into your home without having to invest in a whole new set of furniture.

A moooi boutique sofa will never be out of fashion!

### available covers

	boutique <b>Leather</b>		boutique <b>Medaillon</b>		boutique <b>Travis</b>		boutique <b>Sophy</b>
	boutique <b>Silver</b>		boutique <b>New York</b>		boutique <b>Lace</b>		boutique <b>Kimono</b>
	boutique <b>Jester</b>		boutique <b>Easy Rider</b>		boutique <b>Diary</b>		boutique <b>Deer</b>
	boutique <b>Daddy</b>		boutique <b>Eyes of Strangers</b>		boutique <b>Delft Grey</b>		boutique <b>Delft Blue</b>
	boutique <b>Chameleon Hallingdal</b>		boutique <b>Chameleon Divina Melange</b>		boutique <b>COCO</b>		boutique <b>Manga</b>

## technical Boutique sofa

The Boutique concept is based on the “naked boutique sofa”, a ready to use sofa including seatcushions and which is available as single, double and triple seater. The sofa can be complemented with a matching footstool and matching pillows. All Naked items can be covered with Boutique covers in various designs and compositions. For both the boutique sofa and footstool there is a choice of legs available.

\*the Delft Blue, Delft Grey and Eyes of Strangers pillows have different sizes from the standard boutique pillows.

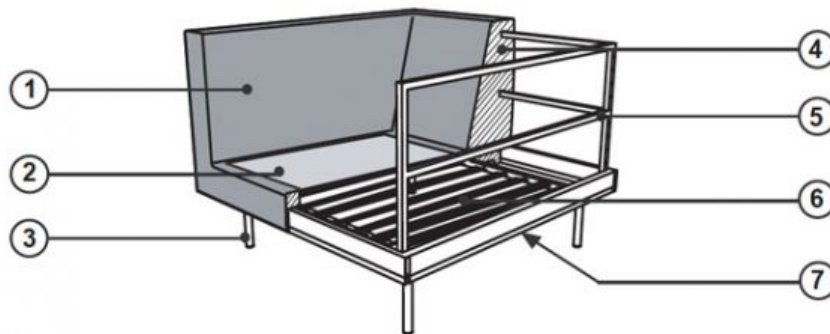

1. Naked Fabric Brown Stripe
2. Hook and Loop Fabric (grey)
3. Boutique Leg (different options) M10 thread
4. Multiple density foam composition and dacron
5. Steel box frame (tubular, welded)
6. Rubber straps
7. Hook and Loop Fabric (black)

## technical boutique footstool

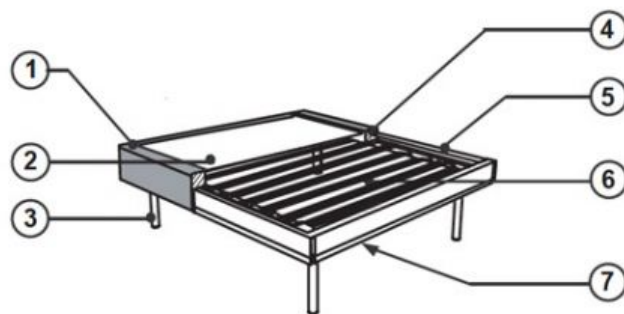

1. Naked Fabric Brown Stripe
2. Hook and Loop Fabric (grey)
3. Boutique Leg (different options) M10 thread
4. Multiple density CMHR foam composition
5. Steel box frame
6. Rubber straps
7. Naked Fabric White Flower

## naked fabric & padding



### mooi brown striped naked fabric composition

30% Polyester, 70% Cotton, FR and Teflon coating

### mooi white flower fabric composition

100% Polyester, FR and Teflon coating.ââ

### mooi pink flower fabric composition

100% Polyester, FR and Teflon coating.



### cushions padding

Multiple density CMHR foam.

### standard pillows padding

CMHR Foam and goosedawn mixture.



---

## packaging

### Triple Seater

H 50 cm | 19.6"  
W 222 cm | 87.4"  
D 90 cm | 35.4"

Colli 1

Product weight:  
64 KG | 143,3 lb

With packaging:  
71 KG | 156,5 lb

### Double Seater

H 50 cm | 19.6"  
W 156 cm | 61.4"  
D 90 cm | 35.4"

Colli 1

Product weight:  
49 KG | 108 lb

With packaging:  
54 KG | 119 lb

### Single Seater

H 50 cm | 19.6"  
W 90 cm | 35.4"  
D 90 cm | 35.4"

Colli 1

Product weight:  
32 KG | 70,5 lb

With packaging:  
36 KG | 79,4 lb

### Footstool

H 30 cm | 11.8"  
W 70 cm | 27.5"  
D 70 cm | 27.5"

Colli 1

Product weight:  
14,5 KG | 31,9 lb

With packaging:  
16 KG | 35,3 lb

---

## cleaning Instructions

Boutique sofas and covers must always be dry cleaned. Do not machine wash and do not apply any cleaning product which contains bleach or bleaching agents. Always read the label of any cleaning product you intend to use on or near any item from the Moooli collection. For further cleaning advice for your Boutique cover or sofa please contact your nearest Moooli agent or dealer located via the Moooli website.

## dimensions

Boutique Sofa

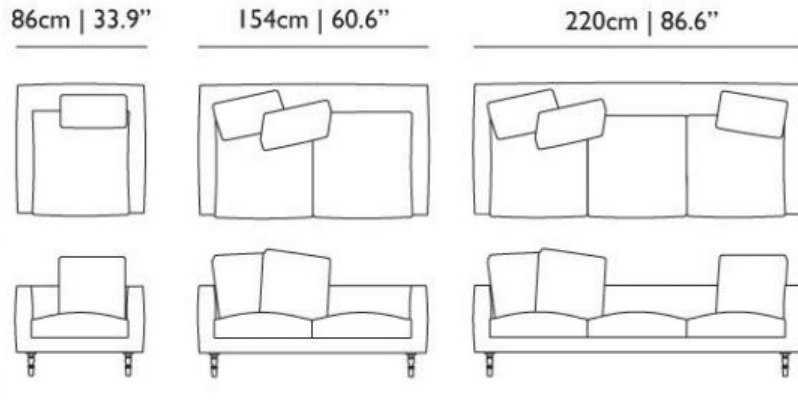

Footstool

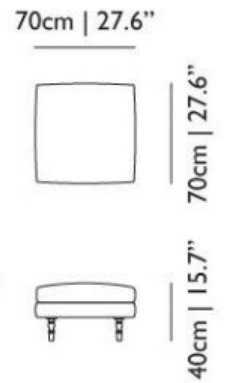

Toes - Heels - Pawn - Skis



Delft Blue Jumper  
Pillow A

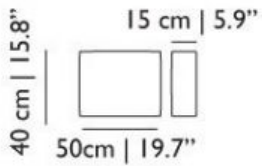

Delft Blue Jumper  
Pillow B

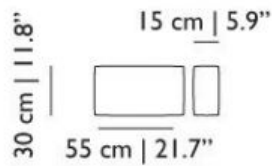

Delft Blue Jumper  
Pillow C

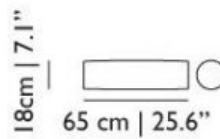

Eyes of Strangers  
Pillow

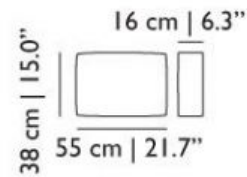

Boutique Pillow

