

m o o o i[®]



Boutique Delft Grey Jumper

Delft Grey Jumper sofa and cushion covers are born to challenge existing assumptions and materials with an unexpected twist. The Boutique sofa collection adds a cable knit 'jumper' to its fashionable wardrobe, bringing sensations of coziness and warmth to the existing assortment.

Designer	Marcel Wanders
Year of design	2011
Material	Kvadrat divina melange 120 (cover), 100% polyester (pillows)
Additional	COF (clients own fabric) is also available with this sofa.

fabric

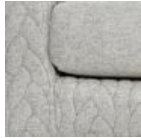

cover & cushions

Kvadrat divina melange 120

composition

100% New Wool

abrasion

45000 Martindale

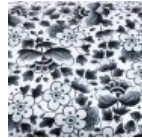

pillows

composition

100% Polyester

abrasion

30000 Martindale

a sofa to fit your personal style, to outlast everyday interiors and to keep up to date forever!

Conceived, developed and designed by Marcel Wanders for Moooi, the Boutique sofa is a timeless piece of furniture. The Boutique sofa contours, dimensions and sheer comfort makes it highly sitter-friendly. With a unique artistic temperament and specially designed fabrics & patterns, it makes it the perfect sofa to brighten up your interior.

The archetype classical form makes this sofa collection ideal to dress with any of the 20 different creative, detailed and fashionable covers. To top it all you can also choose between 5 types of feet! Together, it makes a huge range of possibilities.

boutique feet

Personalize your Boutique sofa with one of these feet.



pawn

Beech with plastic cap



heel

Aluminium with plastic cap



toes black

Casted Aluminium with plastic cap



toes chromed

Casted Aluminium with plastic cap



skis

Chromed steel with felt sliders

boutique covers

You will receive your Boutique sofa dressed with the cover of your choice but changing your Boutique sofa cover is always easy, as all Boutique sofa covers are tailored to fit and simply attached to the sofa with user friendly Velcro fastenings.





















The sofa is upholstered in an extra beautiful underwear fabric to make the installation of a new cover effortless and exciting.

The moment you order your Boutique sofa you can expect it within 2 to 4 weeks.

Moooi will continue to design new covers so that you can keep on bringing the latest style and feel into your home without having to invest in a whole new set of furniture.

A moooi boutique sofa will never be out of fashion!

available covers

	boutique Leather		boutique Medaillon		boutique Travis		boutique Sophy
	boutique Silver		boutique New York		boutique Lace		boutique Kimono
	boutique Jester		boutique Easy Rider		boutique Diary		boutique Deer
	boutique Daddy		boutique Eyes of Strangers		boutique Delft Grey		boutique Delft Blue
	boutique Chameleon Hallingdal		boutique Chameleon Divina Melange		boutique COCO		boutique Manga

technical Boutique sofa

The Boutique concept is based on the “naked boutique sofa”, a ready to use sofa including seatcushions and which is available as single, double and triple seater. The sofa can be complemented with a matching footstool and matching pillows. All Naked items can be covered with Boutique covers in various designs and compositions. For both the boutique sofa and footstool there is a choice of legs available.

*the Delft Blue, Delft Grey and Eyes of Strangers pillows have different sizes from the standard boutique pillows.

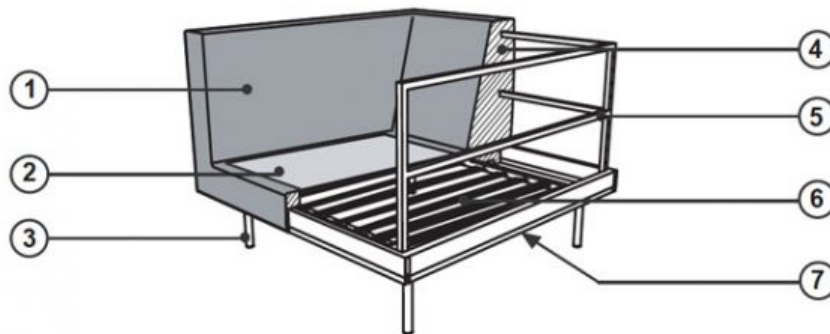

1. Naked Fabric Brown Stripe
2. Hook and Loop Fabric (grey)
3. Boutique Leg (different options) M10 thread
4. Multiple density foam composition and dacron
5. Steel box frame (tubular, welded)
6. Rubber straps
7. Hook and Loop Fabric (black)

technical boutique footstool

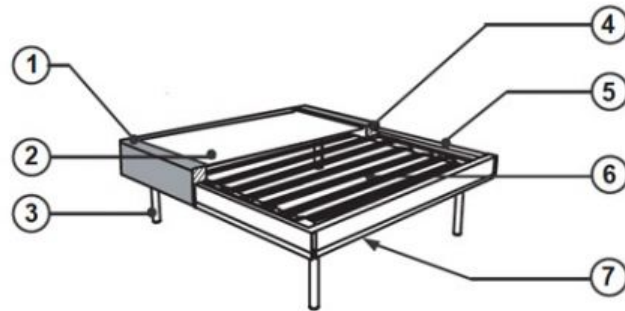

- 1. Naked Fabric Brown Stripe
- 2. Hook and Loop Fabric (grey)
- 3. Boutique Leg (different options) M10 thread
- 4. Multiple density CMHR foam composition
- 5. Steel box frame
- 6. Rubber straps
- 7. Naked Fabric White Flower

technical boutique delft grey pillows

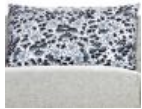

pillow A
Goosedown and flock filling



pillow B
Goosedown and flock filling



pillow C
Foam and Dacron filling

naked fabric & padding



mooi brown striped naked fabric composition

30% Polyester, 70% Cotton, FR and Teflon coating

mooi white flower fabric composition

100% Polyester, FR and Teflon coating.ââ

mooi pink flower fabric composition

100% Polyester, FR and Teflon coating.



cushions padding

Multiple desity CMHR foam.

standard pillows padding

CMHR Foam and goosedawn mixture.

cleaning Instructions

Boutique sofas and covers must always be dry cleaned. Do not machine wash and do not apply any cleaning product which contains bleach or bleaching agents. Always read the label of any cleaning product you intend to use on or near any item from the Moooi collection. For further cleaning advice for your Boutique cover or sofa please contact your nearest Moooi agent or dealer located via the Moooi website.

dimensions

Boutique Sofa

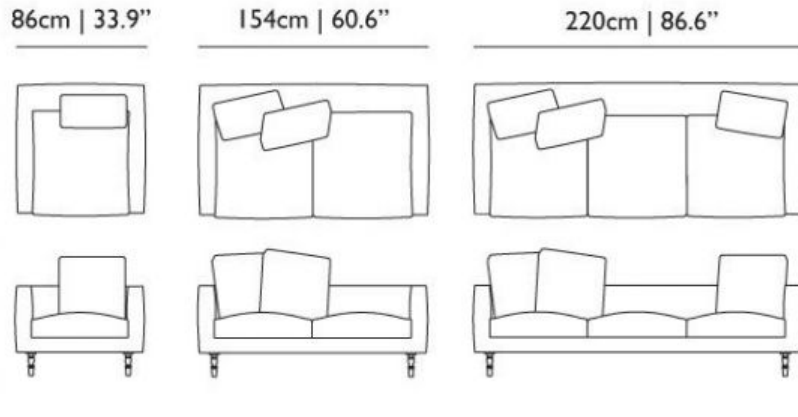

Footstool

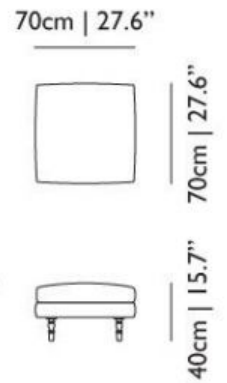

Toes - Heels - Pawn - Skis



Delft Blue Jumper Pillow A

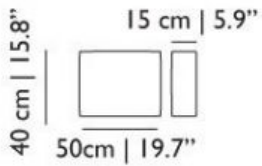

Delft Blue Jumper Pillow B

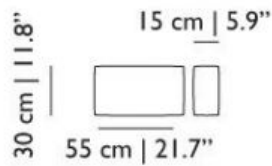

Delft Blue Jumper Pillow C

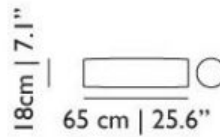

Eyes of Strangers Pillow

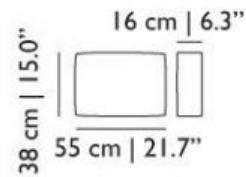

Boutique Pillow

